



Antenna Datasheet

Product OC: YE0013CA

Version: 2.0

Date: 2023-05-04

Status: Released

Product Name: 4G External Antenna

Key Features:

Frequency Band: 698–2700 MHz

Dimensions: Φ 10.2 × 115.4 mm

Efficiency: Up to 95.7 % (On 130 × 130 mm EVB)

RoHS Compliant

IP66

Overview

This Quectel external 4G antenna covers main 4G LTE bands and is compatible with 3G/2G/LPWA bands as well. The external antenna is barely influenced by the internal environment of devices, giving a much better performance in efficiency, radiation and gain whilst providing an optimized solution for a customer product. Quectel also offers flexible installation with custom cable length and connector options.

Contents

Overview	1
Contents	2
1 Specification	3
1.1. Electrical.....	3
1.2. Mechanical, Environmental & Storage.....	5
2 Drawing	6
3 Detailed Performance	7
3.1. S-Parameter Test.....	7
3.1.1. VSWR.....	7
3.1.2. Return Loss.....	8
3.2. Radiation Performance Test.....	9
3.2.1. Efficiency.....	9
3.2.2. Average Gain.....	10
3.2.3. Peak Gain.....	11
3.2.4. 3D & 2D Radiation Pattern.....	12
3.2.4.1. Test Condition: On 130 × 130 mm EVB.....	12
3.2.4.2. Test Condition: Free Space.....	16
4 Packaging	20
Contact Us	22
Legal Notices	23
Revision History	25

1 Specification

Test Condition: On 130 × 130 mm EVB & Free Space

1.1. Electrical

Electrical	
Frequency Range	698–2700 MHz
Impedance	50 Ω
Polarization	Linear
Radiation Pattern	Omni-directional

Electrical - Detail												
SPEC	Band	B71	B12 /B13 /B28	B5 /B8 /B26	N74 /N75 /N76	B1 /B2 /B3	B40	Wi-Fi 2G	B38 /B41	B42 /B48 /N77	N79	Wi-Fi 5G
	Freq. (MHz)	600– 700	700– 810	820– 960	1420– 1520	1700– 2170	2300– 2400	2400– 2500	2500– 2690	3300– 4200	4400– 5000	5150– 5850
Max. VSWR	EVB	-	2.9	3.1	-	2.5	4.6	4.7	4.1	-	-	-
	FS	-	2.1	2.6	-	1.7	2.0	2.2	2.4	-	-	-
Max. Return Loss (dB)	EVB	-	-6.3	-5.8	-	-7.5	-3.9	-3.8	-4.3	-	-	-
	FS	-	-8.9	-7.2	-	-11.9	-9.8	-8.5	-7.7	-	-	-
AVG Eff. (%)	EVB	-	59.2	58.7	-	79.1	52.5	45.4	59.2	-	-	-
	FS	-	38.0	42.8	-	70.4	59.9	65.2	38.0	-	-	-
AVG Gain (dB)	EVB	-	-2.3	-2.3	-	-1.0	-2.8	-3.4	-2.6	-	-	-
	FS	-	-4.3	-3.7	-	-1.5	-2.2	-1.9	-2.1	-	-	-
Max. Peak	EVB	-	1.4	1.7	-	4.9	1.9	1.4	3.9	-	-	-

Gain (dBi)	FS	-	-1.5	-0.9	-	1.9	1.8	2.2	2.6	-	-	-
VSWR	EVB		≤ 4.7									
	FS		≤ 2.6									
Return Loss	EVB		≤ -3.8 dB									
	FS		≤ -7.2 dB									
Peak Gain	EVB		≤ 4.9 dBi									
	FS		≤ 2.6 dBi									

- FS: Free Space
- EVB: On 130 × 130 mm EVB

1.2. Mechanical, Environmental & Storage

Mechanical	
Antenna Dimensions	Φ 10.2 × 115.4 mm
Casing Material & Color	TPEE & Black
Connector Type	SMA Male
Mounting Type	Terminal
Weight	Typ. 17 g
Environmental	
Operation Temperature	-40 °C to +85 °C
Ingress Protection (IP) Rating	IP66
RoHS Compliant	Yes
Storage	
Storage Temperature	18 °C–27 °C
Humidity	30 %–80 % RH
Storage Place	Away from corrosive gas and direct sunlight
Packaging	Antennas should be stored in unopened sealed manufacturer's plastic packaging

2 Drawing

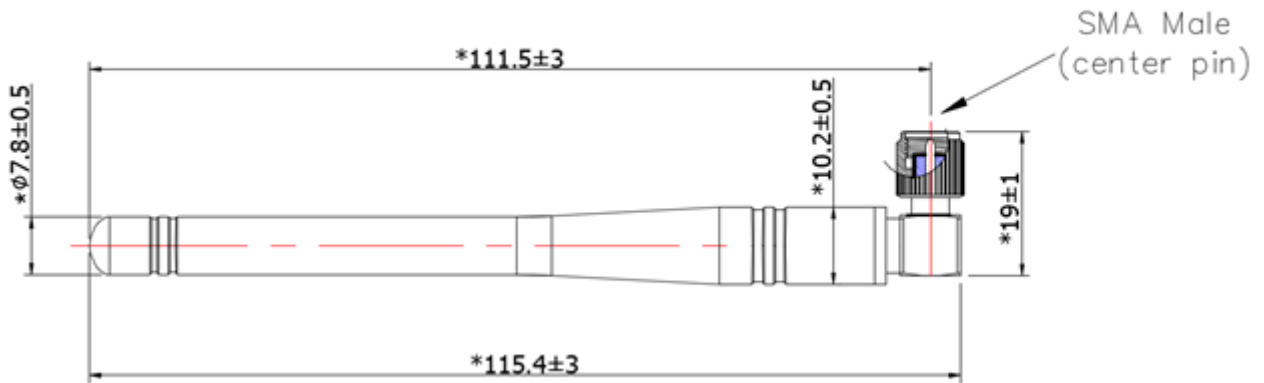

3 Detailed Performance

3.1. S-Parameter Test

3.1.1. VSWR

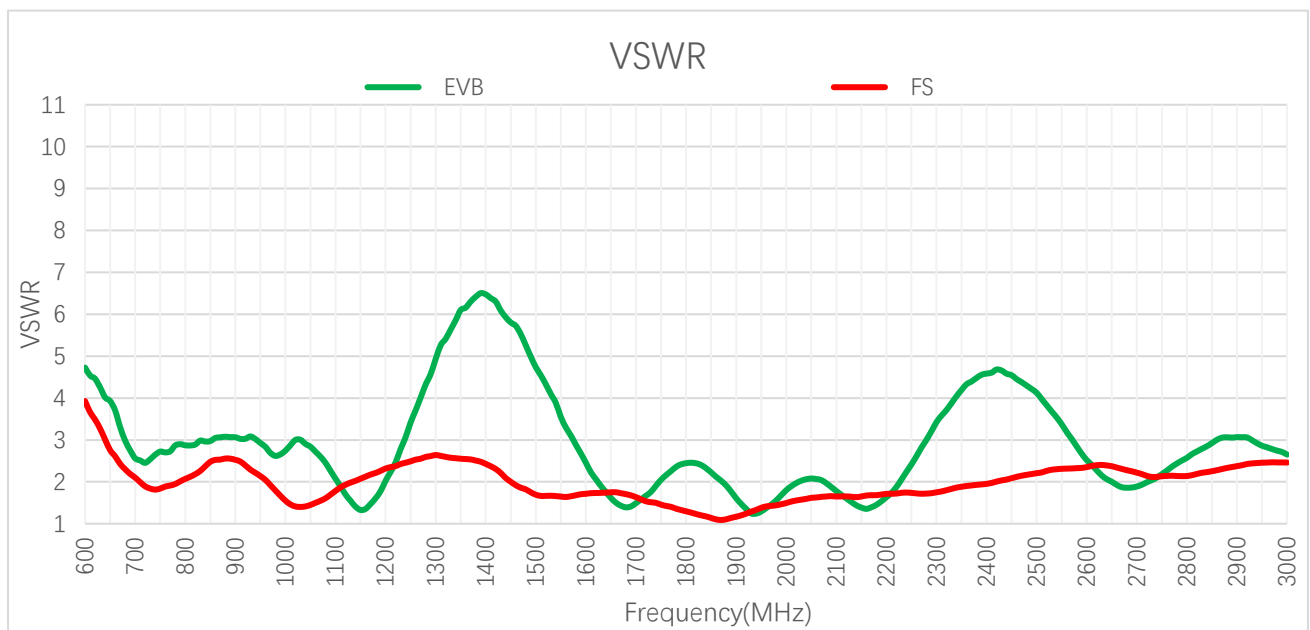

VSWR

Frequency (MHz)		600	630	710	830	900	960	1440	1710	1740	1880
VSWR	EVB	-	-	2.5	3.0	3.1	2.8	-	1.6	1.9	1.9
	FS	-	-	2.0	2.3	2.5	2.0	-	1.6	1.5	1.1
Frequency (MHz)		1950	2140	2350	2450	2600	2690	4700	5000	5500	6000
VSWR	EVB	1.3	1.4	4.2	4.5	2.5	1.9	-	-	-	-
	FS	1.4	1.6	1.9	2.1	2.4	2.3	-	-	-	-

3.1.2. Return Loss

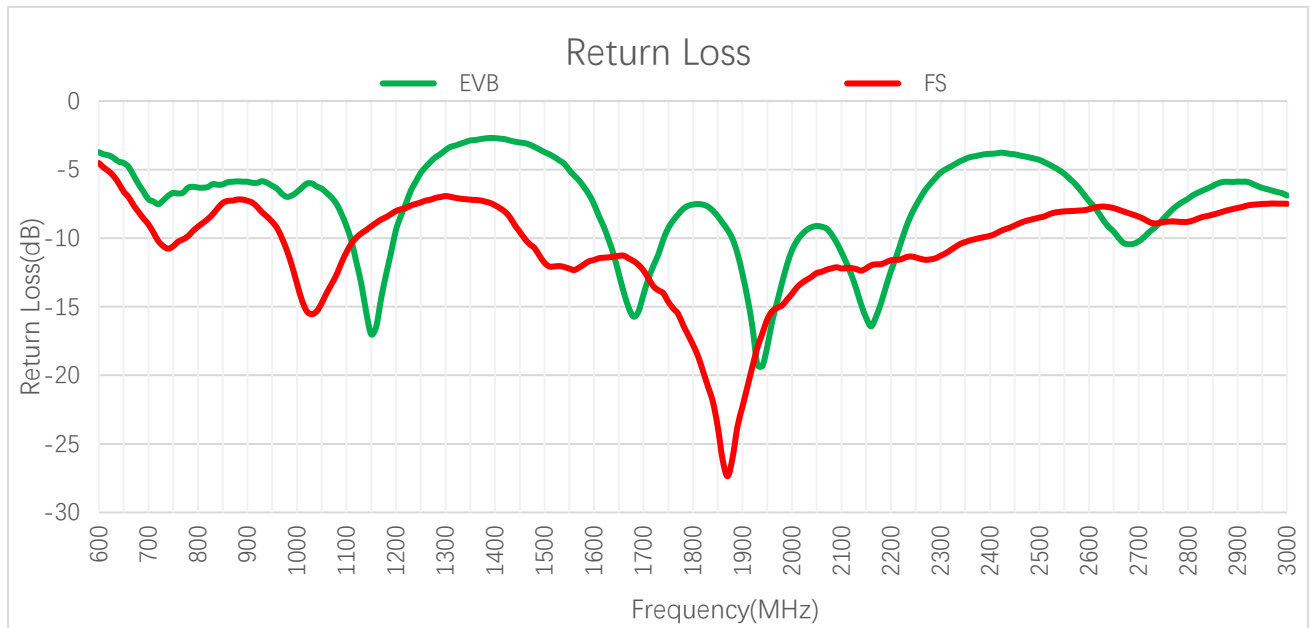

Return Loss (dB)

Frequency (MHz)		600	630	710	830	900	960	1440	1710	1740	1880
Return Loss (dB)	EVB	-	-	-7.3	-6.1	-5.9	-6.4	-	-13.0	-10.1	-10.1
	FS	-	-	-9.6	-8.3	-7.3	-9.3	-	-12.9	-14.0	-26.0
Frequency (MHz)		1950	2140	2350	2450	2600	2690	4700	5000	5500	6000
Return Loss (dB)	EVB	-17.9	-14.9	-4.2	-3.9	-7.3	-10.4	-	-	-	-
	FS	-15.9	-12.4	-10.3	-9.1	-7.9	-8.3	-	-	-	-

3.2. Radiation Performance Test

3.2.1. Efficiency

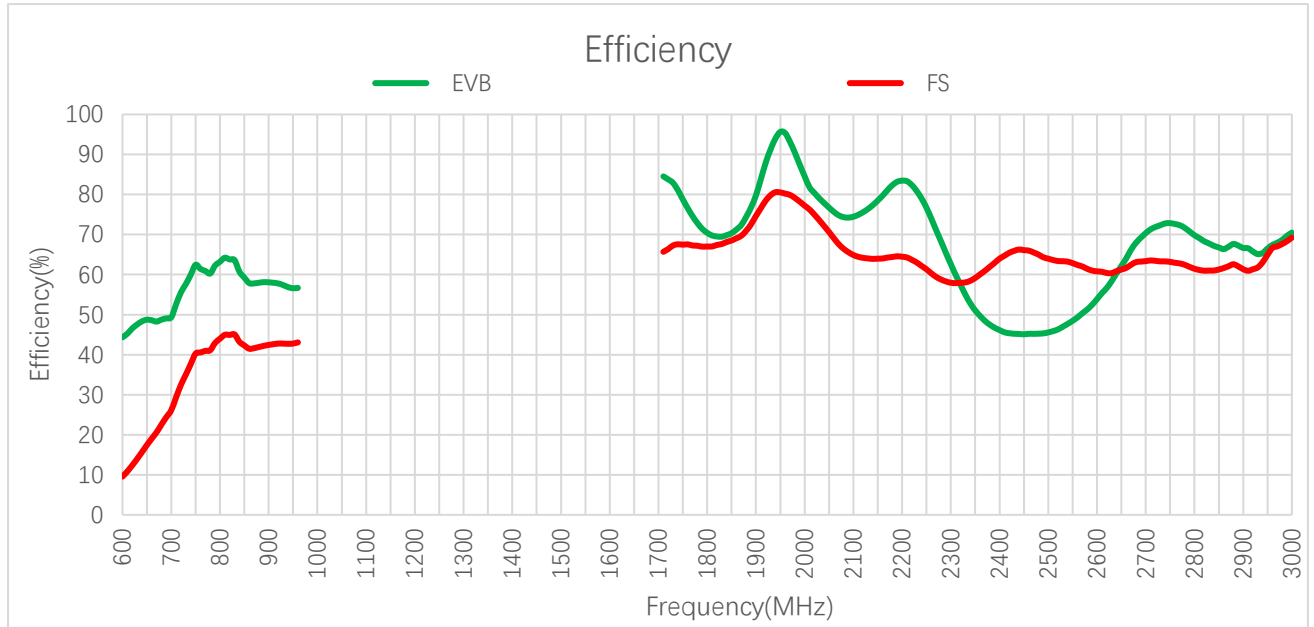

Efficiency (%)

Frequency (MHz)		600	630	710	830	900	960	1440	1710	1740	1880
Efficiency (%)	EVB	-	-	52.6	63.6	58.1	56.7	-	84.5	81.1	74.4
	FS	-	-	29.4	45.1	42.4	43.1	-	65.7	67.6	71.0
Frequency (MHz)		1950	2140	2350	2450	2600	2690	4700	5000	5500	6000
Efficiency (%)	EVB	95.7	77.4	51.1	45.1	53.9	69.2	-	-	-	-
	FS	80.5	63.9	59.2	66.1	60.8	63.3	-	-	-	-

3.2.2. Average Gain

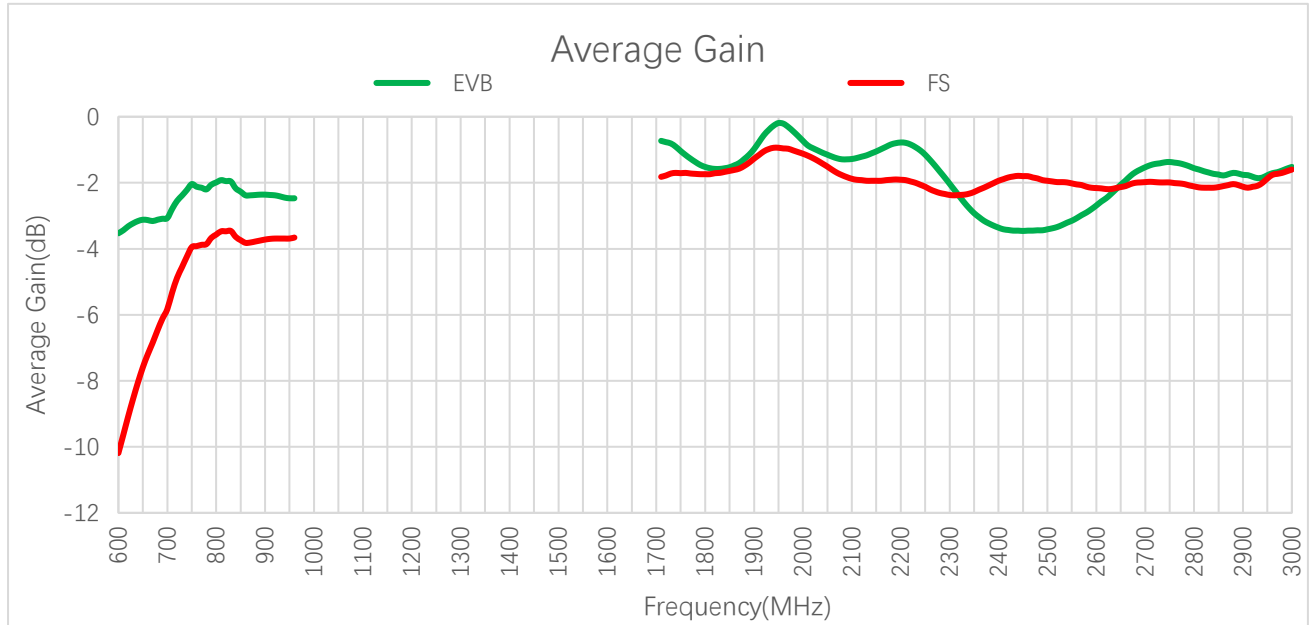

Average Gain (dB)

Frequency (MHz)		600	630	710	830	900	960	1440	1710	1740	1880
Average Gain (dB)	EVB	-	-	-2.8	-2.0	-2.4	-2.5	-	-0.7	-0.9	-1.3
	FS	-	-	-5.3	-3.5	-3.7	-3.7	-	-1.8	-1.7	-1.5
Frequency (MHz)		1950	2140	2350	2450	2600	2690	4700	5000	5500	6000
Average Gain (dB)	EVB	-0.2	-1.1	-2.9	-3.5	-2.7	-1.6	-	-	-	-
	FS	-0.9	-1.9	-2.3	-1.8	-2.2	-2.0	-	-	-	-

3.2.3. Peak Gain

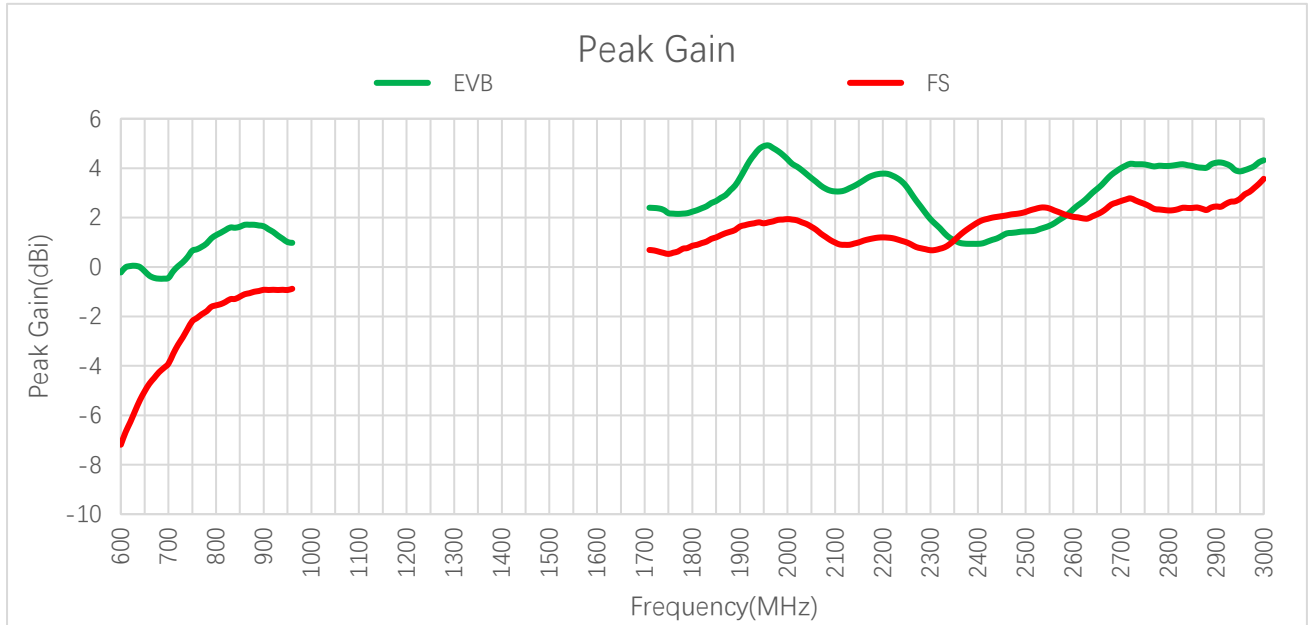

Peak Gain (dBi)

Frequency (MHz)		600	630	710	830	900	960	1440	1710	1740	1880
Peak Gain (dBi)	EVB	-	-	-0.2	1.6	1.7	1.0	-	2.4	2.3	3.1
	FS	-	-	-3.5	-1.3	-0.9	-0.9	-	0.7	0.6	1.4
Frequency (MHz)		1950	2140	2350	2450	2600	2690	4700	5000	5500	6000
Peak Gain (dBi)	EVB	4.9	3.3	1.1	1.3	2.3	3.9	-	-	-	-
	FS	1.8	1.0	1.1	2.1	2.0	2.6	-	-	-	-

3.2.4. 3D & 2D Radiation Pattern

3.2.4.1. Test Condition: On 130 × 130 mm EVB

- Test Chamber: GL-S-1

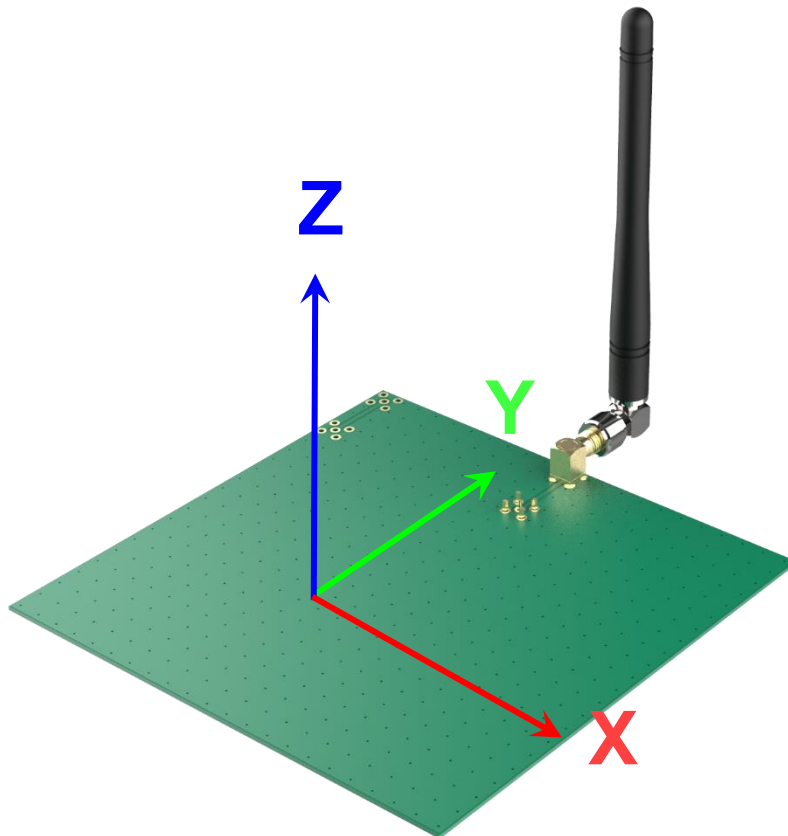

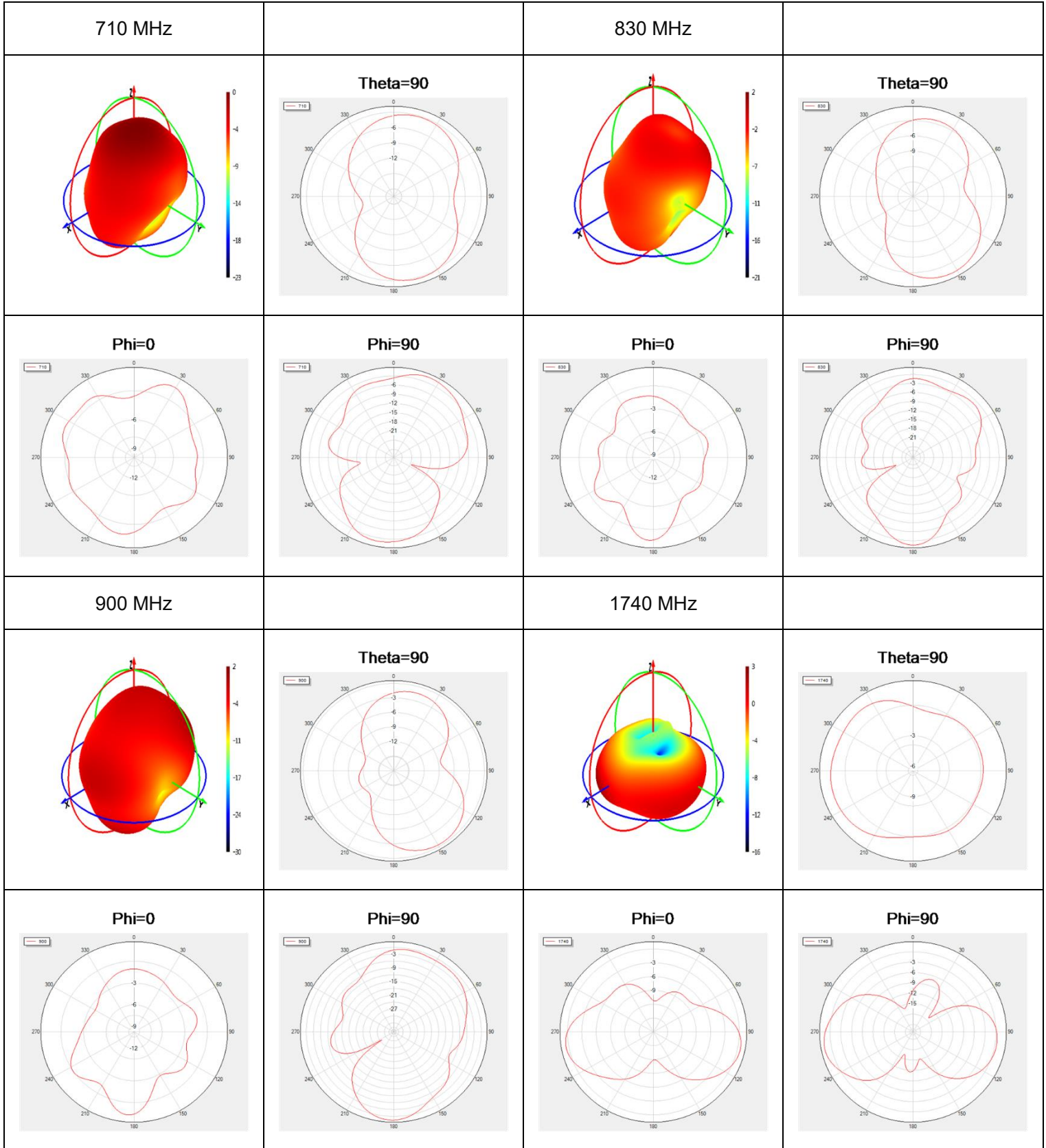

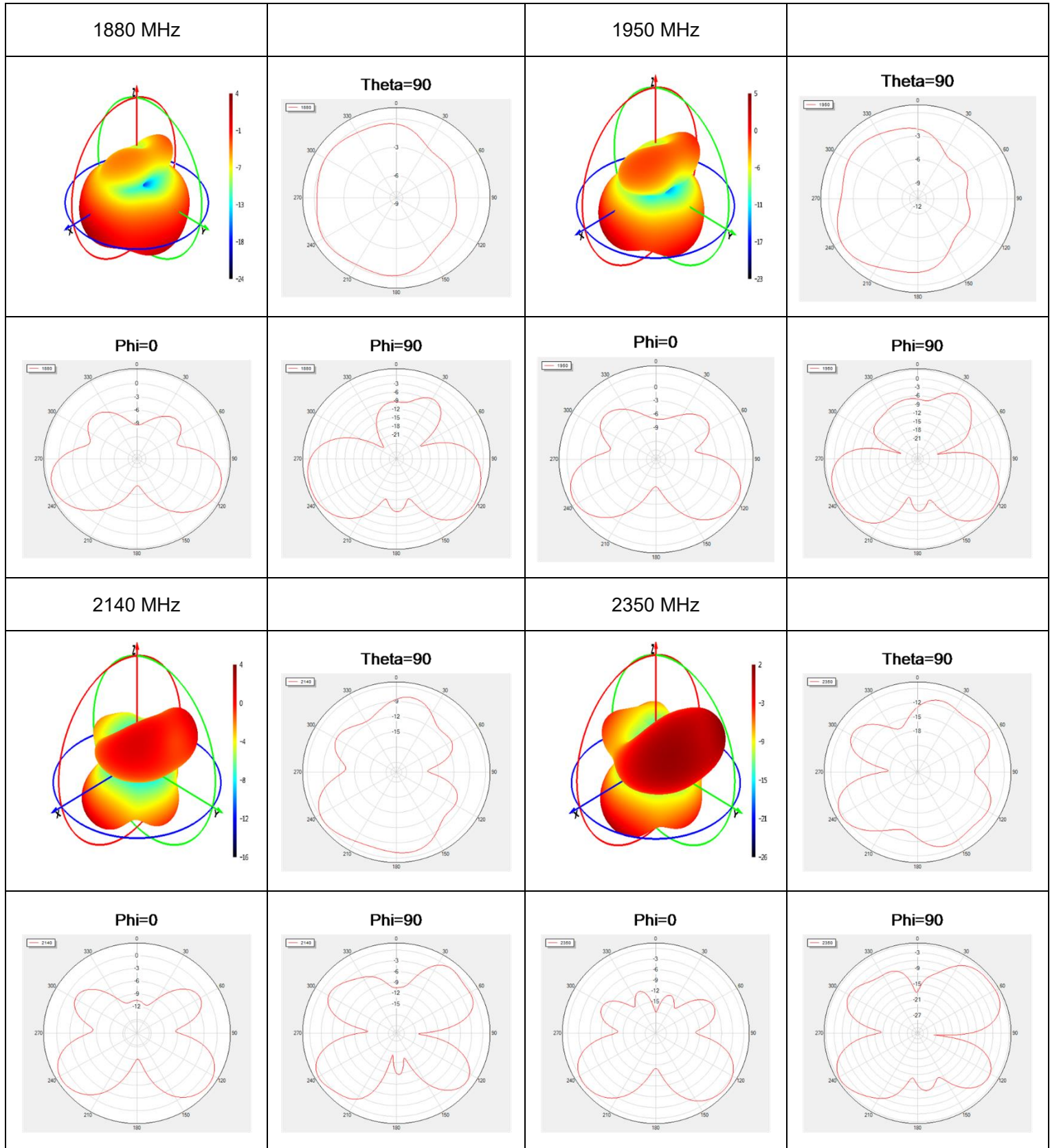

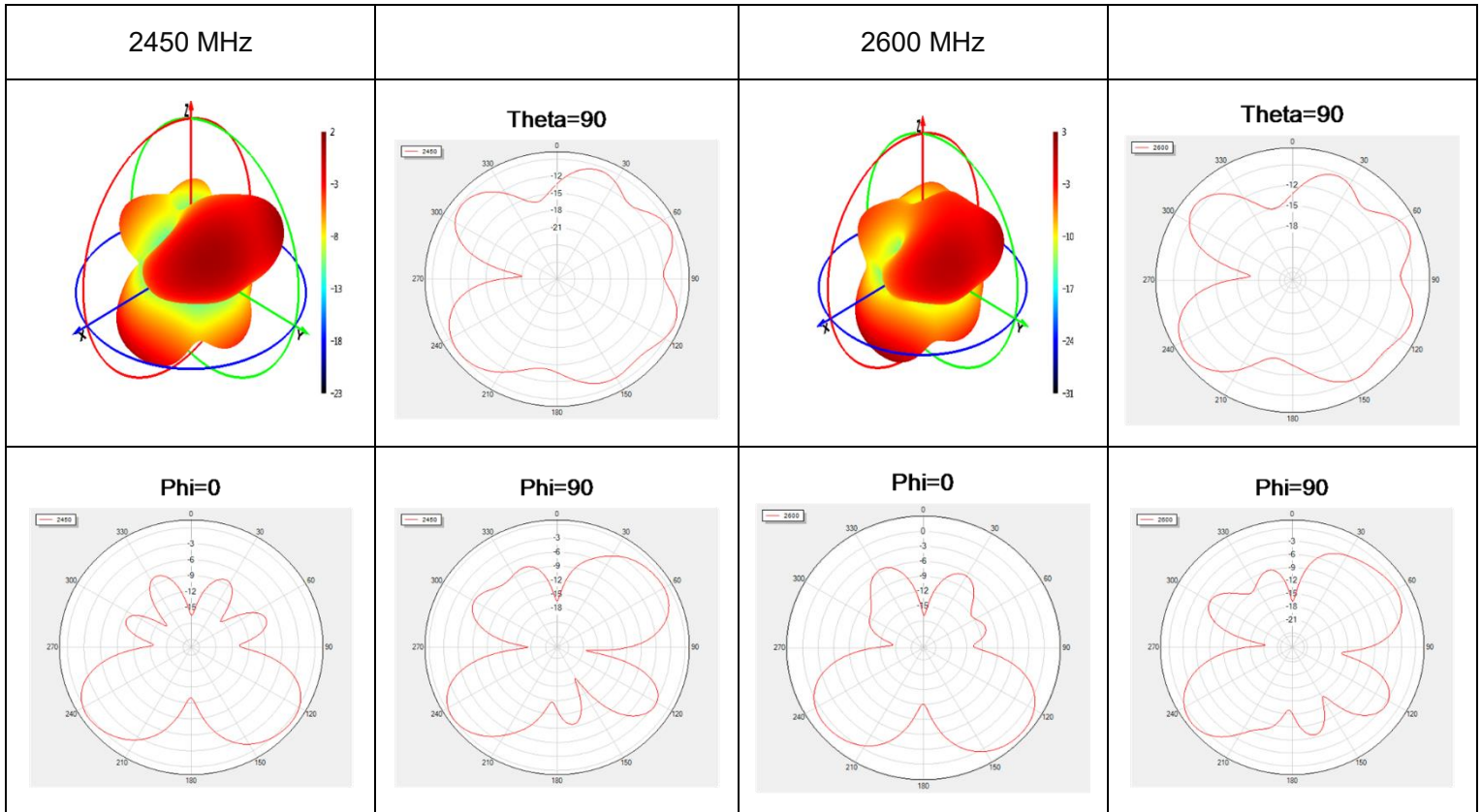

3.2.4.2. Test Condition: Free Space

- Test Chamber: GL-S-1

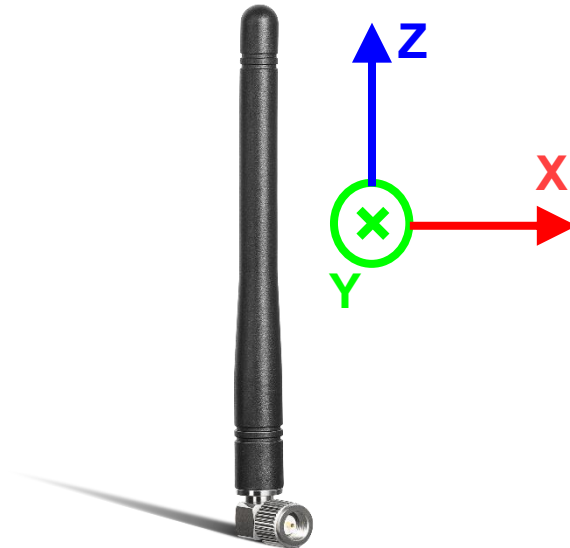

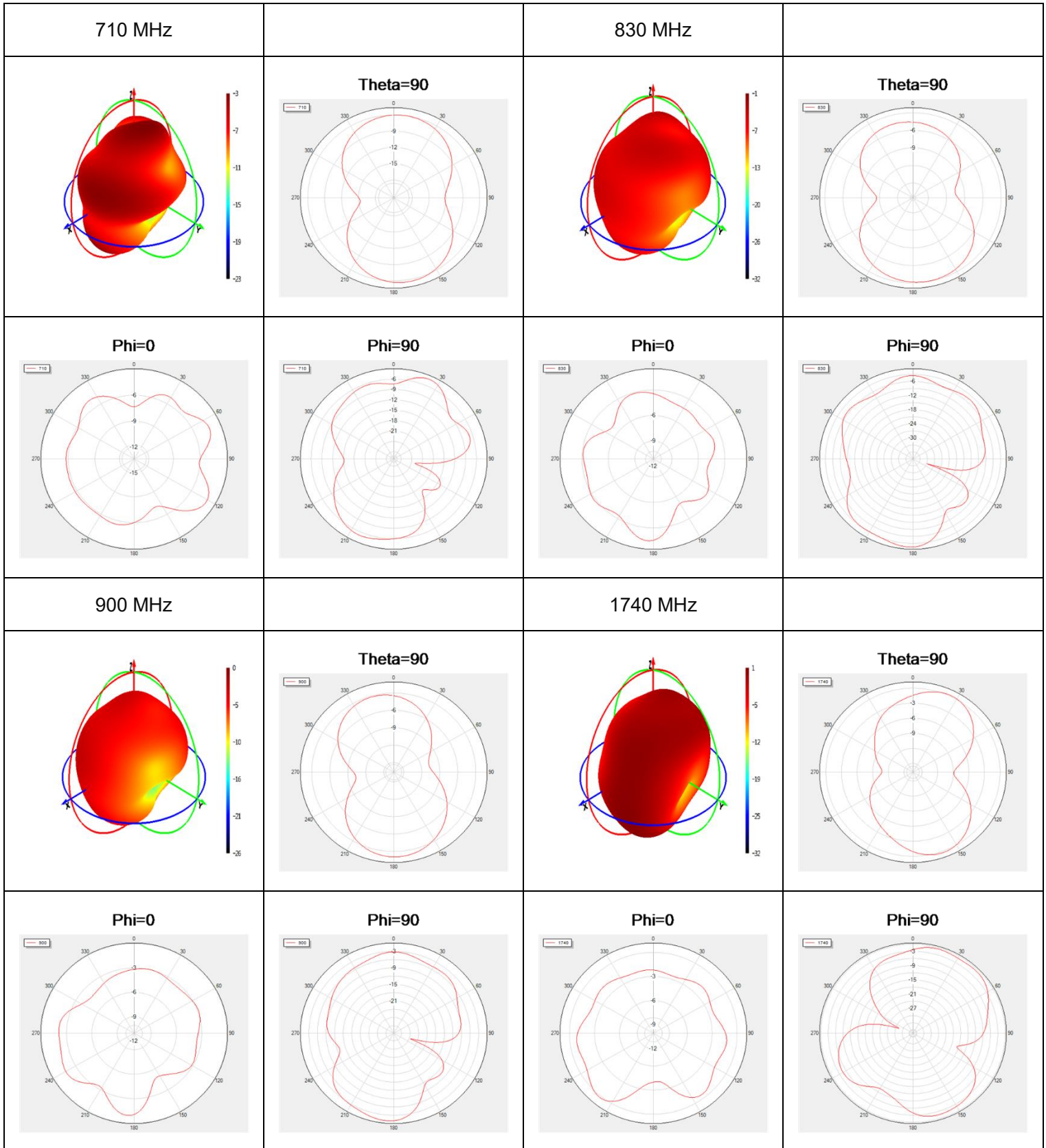

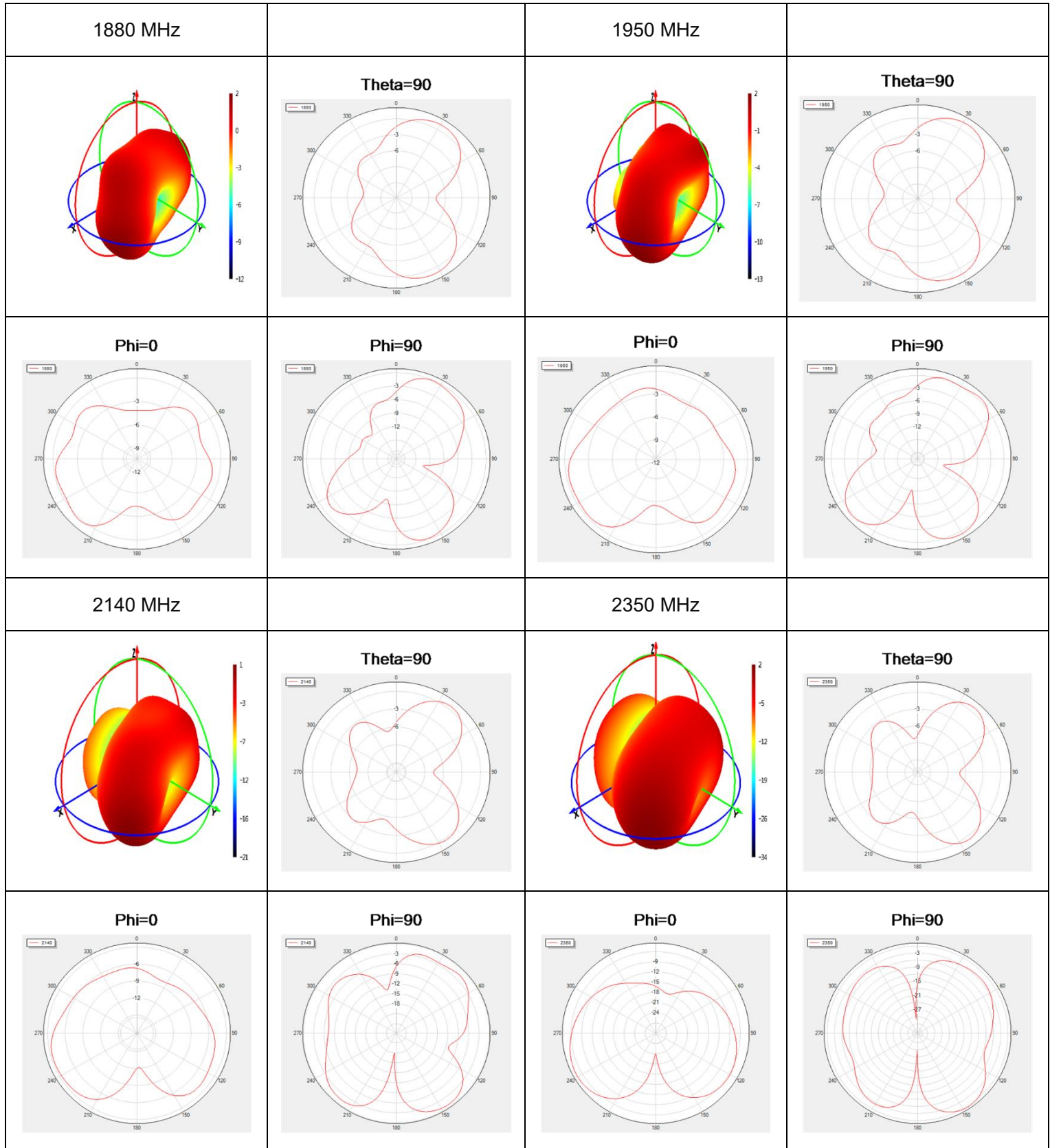

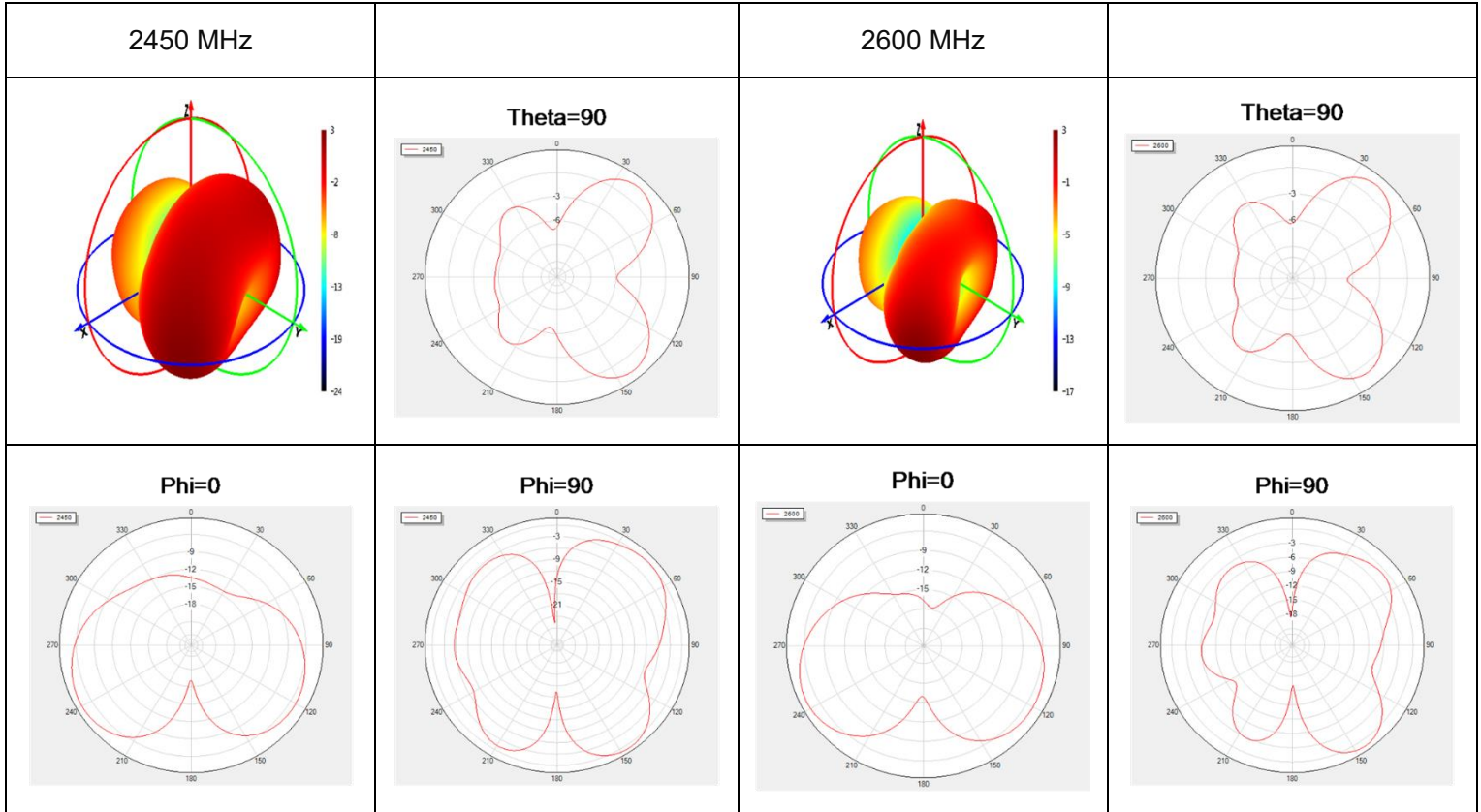

4 Packaging

Step	Packaging Picture / 2D Picture	Description
1		<p>Put the product in a one-piece bag; Each one-piece bag contains 10 products.</p>
2		<p>20 pcs antenna products in a PE bag; (20 pcs antennas per PE bag)</p>
3		<p>(30 PE bags per carton box) (600 pcs antennas per carton box)</p> <p><u>Carton Size:</u> <u>L × W × H = 325 × 325 × 200 mm</u></p>

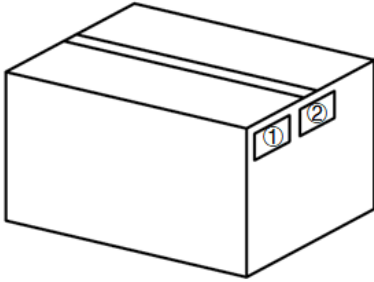
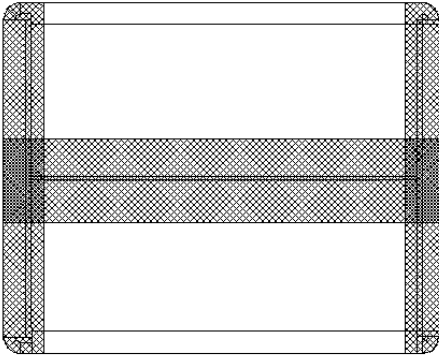
4		<p>Position for Attaching Labels</p> <ul style="list-style-type: none">① Carton Label② Quality Label
5		<p>Sealing Cartons “工” type sealing cartons</p>

Contact Us

At Quectel, our aim is to provide timely and comprehensive services to our customers. If you require any assistance, please contact our headquarters:

Quectel Wireless Solutions Co., Ltd.

Building 5, Shanghai Business Park Phase III (Area B), No.1016 Tianlin Road, Minhang District, Shanghai 200233, China

Tel: +86 21 5108 6236

Email: info@quectel.com

Or our local offices. For more information, please visit:

<http://www.quectel.com/support/sales.htm>.

For technical support, or to report documentation errors, please visit:

<http://www.quectel.com/support/technical.htm>.

Or email us at: support@quectel.com.

Legal Notices

We offer information as a service to you. The provided information is based on your requirements and we make every effort to ensure its quality. You agree that you are responsible for using independent analysis and evaluation in designing intended products, and we provide reference designs for illustrative purposes only. Before using any hardware, software or service guided by this document, please read this notice carefully. Even though we employ commercially reasonable efforts to provide the best possible experience, you hereby acknowledge and agree that this document and related services hereunder are provided to you on an “as available” basis. We may revise or restate this document from time to time at our sole discretion without any prior notice to you.

Use and Disclosure Restrictions

License Agreements

Documents and information provided by us shall be kept confidential, unless specific permission is granted. They shall not be accessed or used for any purpose except as expressly provided herein.

Copyright

Our and third-party products hereunder may contain copyrighted material. Such copyrighted material shall not be copied, reproduced, distributed, merged, published, translated, or modified without prior written consent. We and the third party have exclusive rights over copyrighted material. No license shall be granted or conveyed under any patents, copyrights, trademarks, or service mark rights. To avoid ambiguities, purchasing in any form cannot be deemed as granting a license other than the normal non-exclusive, royalty-free license to use the material. We reserve the right to take legal action for noncompliance with abovementioned requirements, unauthorized use, or other illegal or malicious use of the material.

Trademarks

Except as otherwise set forth herein, nothing in this document shall be construed as conferring any rights to use any trademark, trade name or name, abbreviation, or counterfeit product thereof owned by Quectel or any third party in advertising, publicity, or other aspects.

Third-Party Rights

This document may refer to hardware, software and/or documentation owned by one or more third parties (“third-party materials”). Use of such third-party materials shall be governed by all restrictions and obligations applicable thereto.

We make no warranty or representation, either express or implied, regarding the third-party materials, including but not limited to any implied or statutory, warranties of merchantability or fitness for a particular purpose, quiet enjoyment, system integration, information accuracy, and non-infringement of any third-party intellectual property rights with regard to the licensed technology or use thereof. Nothing herein constitutes a representation or warranty by us to either develop, enhance, modify, distribute, market, sell, offer for sale, or otherwise maintain production of any our products or any other hardware, software, device, tool, information, or product. We moreover disclaim any and all warranties arising from the course of dealing or usage of trade.

Privacy Policy

To implement module functionality, certain device data are uploaded to Quectel's or third-party's servers, including carriers, chipset suppliers or customer-designated servers. Quectel, strictly abiding by the relevant laws and regulations, shall retain, use, disclose or otherwise process relevant data for the purpose of performing the service only or as permitted by applicable laws. Before data interaction with third parties, please be informed of their privacy and data security policy.

Disclaimer

- a) We acknowledge no liability for any injury or damage arising from the reliance upon the information.
- b) We shall bear no liability resulting from any inaccuracies or omissions, or from the use of the information contained herein.
- c) While we have made every effort to ensure that the functions and features under development are free from errors, it is possible that they could contain errors, inaccuracies, and omissions. Unless otherwise provided by valid agreement, we make no warranties of any kind, either implied or express, and exclude all liability for any loss or damage suffered in connection with the use of features and functions under development, to the maximum extent permitted by law, regardless of whether such loss or damage may have been foreseeable.
- d) We are not responsible for the accessibility, safety, accuracy, availability, legality, or completeness of information, advertising, commercial offers, products, services, and materials on third-party websites and third-party resources.

Copyright © Quectel Wireless Solutions Co., Ltd. 2023. All rights reserved.

Revision History

Version	Date	Author	Note
-	2022-06-10	Toby WANG/ Riona HAN	Creation of the document
1.0	2022-06-10	Toby WANG/ Riona HAN	First official release
2.0	2023-05-04	Black LI/ Lucky FENG/ David LIU/ Aria CHU	Updated all data and datasheet template.

QUECTEL

www.quectel.com